

SYSTEMATIC ORGANISATION

LISTA drawer partition materials create systematic order for all industries and all requirements. From small parts to NC tools, our plastic boxes, troughs, metal dividers and more provide flexible solutions for practically any kind of storage item. The results speak for themselves: because systematic organisation means less time searching for stored items, simplified workflows and efficient results.

+ Wide range of specifications in a modular system

with preconfigured sets and freely combinable individual elements such as slotted partitions, metal dividers, plastic boxes, troughs, etc.

+ Fully combinable

with the entire LISTA range thanks to the standardised unit of measure

+ Fast and easy assembly

the walls surrounding the interior of the drawers have a slotted grid and the bottoms of the drawers are perforated for the insertion and attachment of slotted partitions, metal dividers, milling cutter holders and holding pins

+ Professional labelling

with LISTA Script labelling software for labels, clip-on label holders and barcode holders

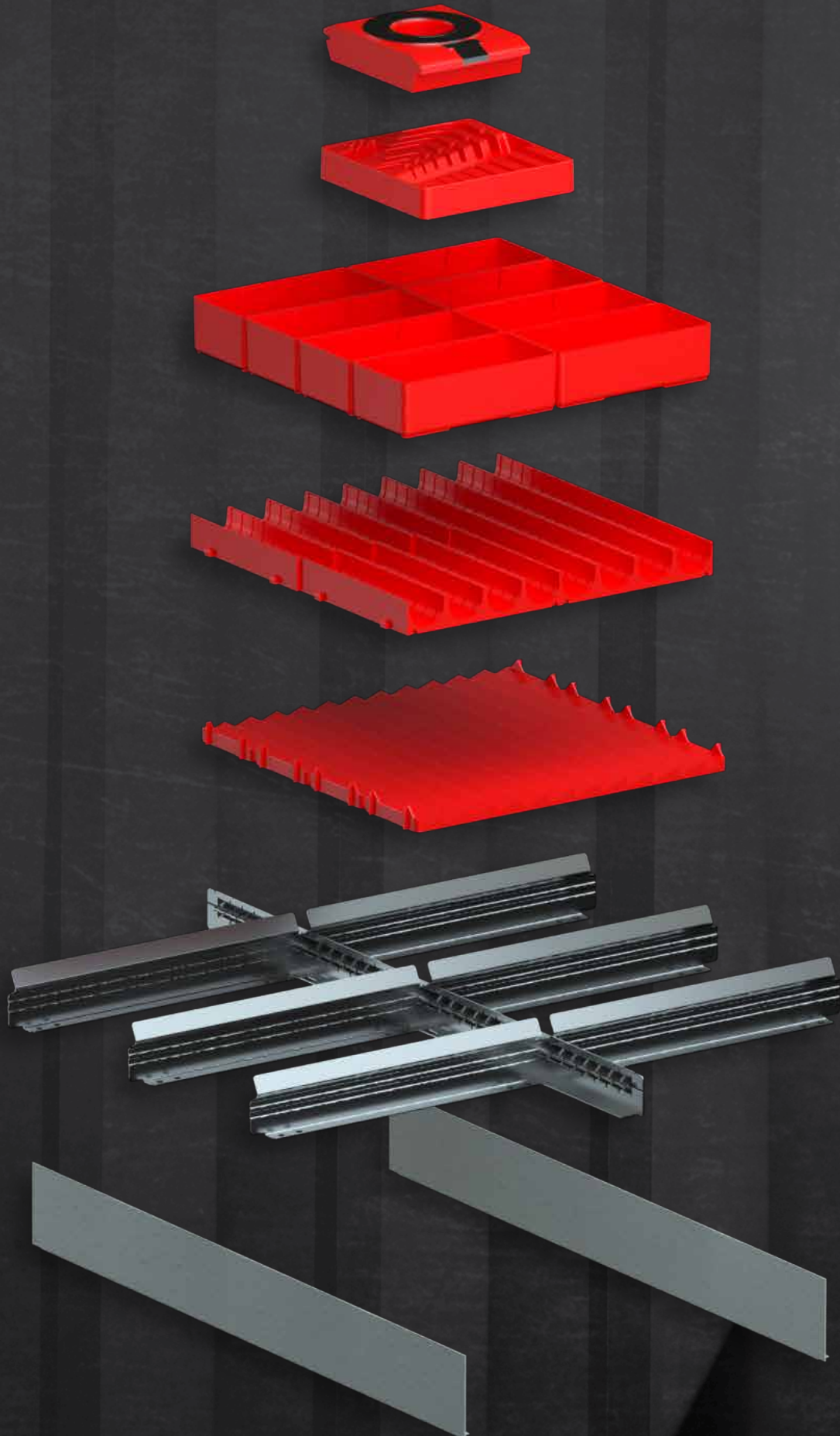

Partition material

+ One system, many different options

Thanks to the LISTA Unit measuring system, our partition materials can be freely combined and are compatible with the entire LISTA range. This means that you have the ideal storage system for your particular storage items – either as individual parts or as a preconfigured set.

+ The LISTA Unit (E) – the clever measurement system

Using a practical grid system, the LISTA unit (E) ensures that housings, drawers and partition materials always fit neatly together. **A LISTA unit (E) is 17 mm** and is based on the grid system for partitioning drawers. Drawer cabinet housings and the drawers that fit into this housing are based on the same LISTA Units, even though they have different dimensions.

Determining the right partition material:

1. Determine the drawer size in LISTA Units (E)
2. Determine the dimensions of the set or the individual parts in LISTA Units (E)
3. The sum in Units of the individual parts must not exceed the sum in Units of the drawer(s)
Take the usable height of the drawer into account according to the goods to be stored.

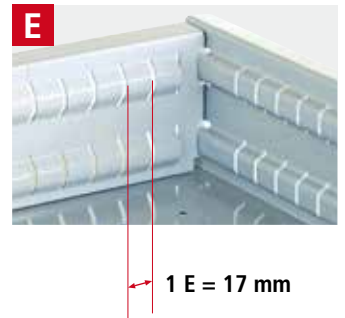

» For more information, see fold-out.



+ Wide range of specifications in a modular system



Plastic boxes

- perfect for small parts of various sizes
- also available in ESD



Troughs

- for cylindrical items
- can be divided lengthwise as desired
- also available in ESD



Slotted partitions and metal dividers

- for flexible partitioning
- for parts of different sizes



Holding pins and non-slip mats

- ideal for larger items

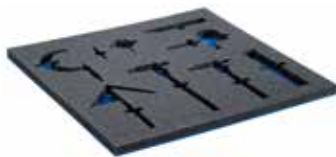

Foam inserts with blue underlays

- protects tools and other items and keeps them organised
- hold items firmly in place in the drawer



NC tool holders

- for neat and orderly storage of NC items

» For NC storage and transport systems see p. 100



LISTA Script

- clip-on label holders for plastic boxes, troughs and metal dividers
- helps you keep an overview of your inventory and can easily be read by a barcode scanner

» LISTA Script see p. 268



The entire LISTA range can be found online at www.lista.com.

You can find our LISTA Script labelling software on our [website](http://www.lista.com) under **Products › Accessories › LISTA Script**



18 × 27 E

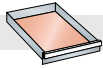

306 × 459 mm

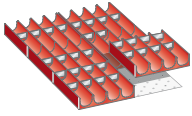

Troughs

For front height mm	Art. no.
50	80.377.000
6 troughs:	4-piece, Ø 33 mm*
30 trough dividers:	4-piece, Ø 33 mm*

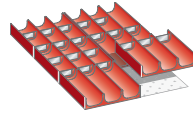

Troughs

For front height mm	Art. no.
50	80.378.000
6 troughs:	3-piece, Ø 45 mm*
20 trough dividers:	3-piece, Ø 45 mm*

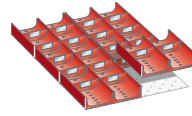

Troughs

For front height mm	Art. no.
50	80.379.000
6 troughs:	2-piece, Ø 70 mm*
20 trough dividers:	2-piece, Ø 70 mm*

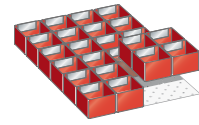

Plastic boxes

For front height mm	Art. no.
50	80.372.000
75	80.414.000
24 plastic boxes:	75 × 75 mm

* Take the usable height of the drawer into account according to the goods to be stored.

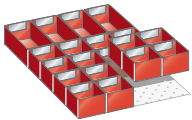

Plastic boxes

For front height mm	Art. no.
50	80.368.000
75	80.412.000
16 plastic boxes:	75 × 75 mm
4 plastic boxes:	75 × 150 mm

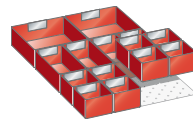

Plastic boxes

For front height mm	Art. no.
50	80.370.000
75	80.413.000
8 plastic boxes:	75 × 75 mm
4 plastic boxes:	75 × 150 mm
2 plastic boxes:	150 × 150 mm

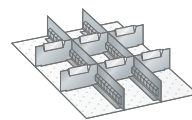

Slotted partitions and metal dividers

For front height mm	Art. no.
50	80.639.000
75	80.640.000
100	80.641.000
150	80.642.000
2 slotted partitions:	27 E
6 metal dividers:	6 E

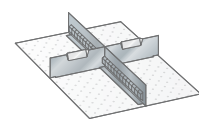

Slotted partitions and metal dividers

For front height mm	Art. no.
50	80.643.000
75	80.644.000
100	80.645.000
150	80.646.000
200	80.647.000
300	80.648.000
1 slotted partition:	27 E
2 metal dividers:	9 E



27 × 27 E

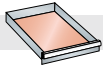

459 × 459 mm

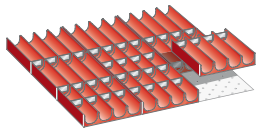

Troughs

For front height mm	Art. no.
50	80.656.000
9 troughs:	4-piece, Ø 33 mm*
40 trough dividers:	4-piece, Ø 33 mm*

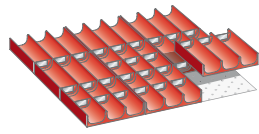

Troughs

For front height mm	Art. no.
50	80.657.000
9 troughs:	3-piece, Ø 45 mm*
30 trough dividers:	3-piece, Ø 45 mm*

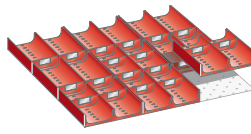

Troughs

For front height mm	Art. no.
50	80.658.000
9 troughs:	2-piece, Ø 70 mm*
20 trough dividers:	2-piece, Ø 70 mm*

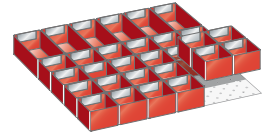

Plastic boxes

For front height mm	Art. no.
50	80.659.000
75	80.660.000
24 plastic boxes:	75 × 75 mm
6 plastic boxes:	150 × 75 mm

* Take the usable height of the drawer into account according to the goods to be stored.

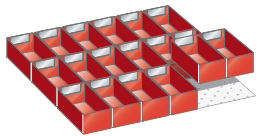

Plastic boxes

For front height mm	Art. no.
50	80.661.000
75	80.662.000
100, 125	80.663.000
18 plastic boxes:	150 × 75 mm

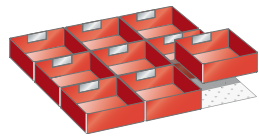

Plastic boxes

For front height mm	Art. no.
50	80.664.000
75	80.665.000
100, 125	80.666.000
9 plastic boxes:	150 × 150 mm

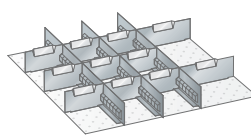

Slotted partitions and metal dividers

For front height mm	Art. no.
50	80.667.000
75	80.668.000
100, 125	80.669.000
150	80.670.000
3 slotted partitions:	27 E
9 metal dividers:	6 E
2 metal dividers:	9 E

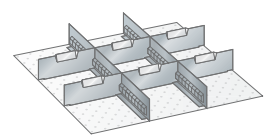

Slotted partitions and metal dividers

For front height mm	Art. no.
50	80.671.000
75	80.672.000
100, 125	80.673.000
150	80.674.000
200	80.675.000
250	80.676.000
300	80.677.000
2 slotted partitions:	27 E
6 metal dividers:	9 E

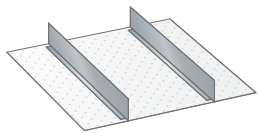

Dividers

For front height mm	Art. no.
75	100.315.000
100, 125	100.130.000
150	100.131.000
200	100.132.000
250	100.133.000
2 dividers:	27 E

Note

The front height is the same as the height of the drawer front. For the actual height of the partition material see p. 262–265.

Partition material sets excluding clip-on label holder.

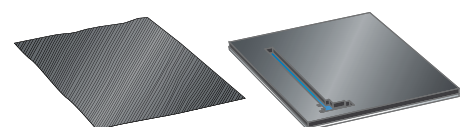

» Non-slip mats and PE foam inserts, see p. 267



36 × 27 E

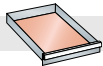

612 × 459 mm

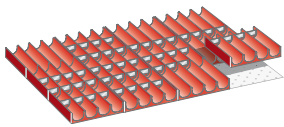

Troughs

For front height
mm

Art. no.

50 **100.283.000**

12 troughs: 4-piece, Ø 33 mm*
50 trough dividers: 4-piece, Ø 33 mm*

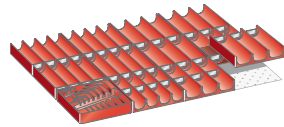

Trough and Allen key insert

For front height
mm

Art. no.

50 **100.312.000**

5 troughs: 4-piece, Ø 33 mm*
20 trough dividers: 4-piece, Ø 33 mm*
6 troughs: 3-piece, Ø 45 mm*
20 trough dividers: 3-piece, Ø 45 mm*
1 Allen key insert

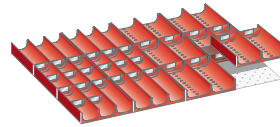

Troughs

For front height
mm

Art. no.

50 **100.313.000**

6 troughs: 3-piece, Ø 45 mm*
20 trough dividers: 3-piece, Ø 45 mm*
6 troughs: 2-piece, Ø 70 mm*
10 trough dividers: 2-piece, Ø 70 mm*

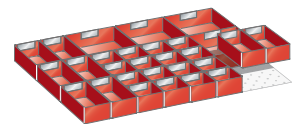

Plastic boxes

For front height
mm

Art. no.

50 **100.290.000**

75 **100.291.000**

16 plastic boxes: 75 × 75 mm
8 plastic boxes: 150 × 75 mm
4 plastic boxes: 150 × 150 mm

*Take the usable height of the drawer into account according to the goods to be stored.

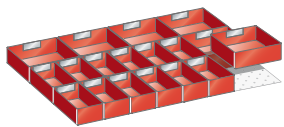

Plastic boxes

For front height
mm

Art. no.

50 **100.292.000**

75 **100.293.000**

100, 125 **100.294.000**

12 plastic boxes: 150 × 75 mm
6 plastic boxes: 150 × 150 mm

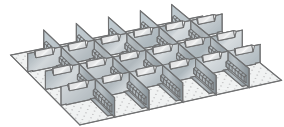

Slotted partitions and metal dividers

For front height
mm

Art. no.

50 **100.950.000**

75 **100.951.000**

100, 125 **100.952.000**

150 **100.953.000**

5 slotted partitions: 27 E
18 metal dividers: 6 E

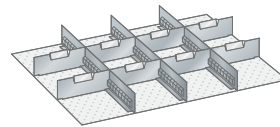

Slotted partitions and metal dividers

For front height
mm

Art. no.

50 **80.649.000**

75 **100.314.000**

100, 125 **80.651.000**

150 **80.652.000**

200 **80.653.000**

250 **80.654.000**

3 slotted partitions: 27 E
8 metal dividers: 9 E

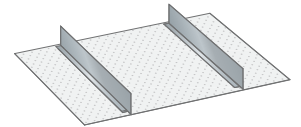

Dividers

For front height
mm

Art. no.

75 **100.315.000**

100, 125 **100.130.000**

150 **100.131.000**

200 **100.132.000**

250 **100.133.000**

2 dividers 27 E

54 × 27 E

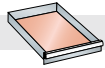

918 × 459 mm

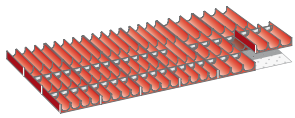

Troughs

For front height mm	Art. no.
75	80.001.000
12 troughs:	4-piece, Ø 33 mm*
30 trough dividers:	4-piece, Ø 33 mm*
6 troughs:	3-piece, Ø 45 mm*
10 trough dividers:	3-piece, Ø 45 mm*

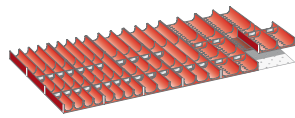

Troughs

For front height mm	Art. no.
75, 100, 125	80.002.000
6 troughs:	4-piece, Ø 33 mm*
20 trough dividers:	4-piece, Ø 33 mm*
6 troughs:	3-piece, Ø 45 mm*
10 trough dividers:	3-piece, Ø 45 mm*
6 troughs:	2-piece, Ø 70 mm*
10 trough dividers:	2-piece, Ø 70 mm*

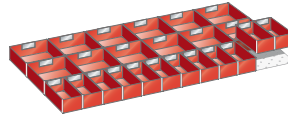

Plastic boxes

For front height mm	Art. no.
50	80.045.000
75	80.046.000
100, 125	80.047.000
12 plastic boxes:	150 × 75 mm
12 plastic boxes:	150 × 150 mm

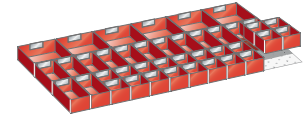

Plastic boxes

For front height mm	Art. no.
50	80.043.000
75	80.044.000
20 plastic boxes:	75 × 75 mm
14 plastic boxes:	150 × 75 mm
6 plastic boxes:	150 × 150 mm

* Take the usable height of the drawer into account according to the goods to be stored.

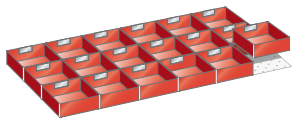

Plastic boxes

For front height mm	Art. no.
50	80.419.000
75	80.049.000
100, 125	80.050.000
18 plastic boxes:	150 × 150 mm

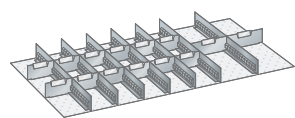

Slotted partitions and metal dividers

For front height mm	Art. no.
50	80.003.000
75	80.004.000
100, 125	80.005.000
7 slotted partitions:	27 E
12 metal dividers:	6 E
2 metal dividers:	9 E

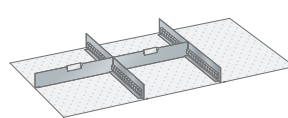

Slotted partitions and metal dividers

For front height mm	Art. no.
50	80.425.000
75	80.426.000
100, 125	80.427.000
150	80.428.000
200	80.429.000
250	80.430.000
300	80.431.000

2 slotted partitions: 27 E
2 metal dividers: 18 E

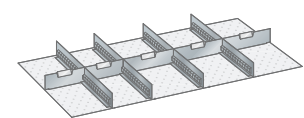

Slotted partitions and metal dividers

For front height mm	Art. no.
50	80.015.000
75	80.016.000
100, 125	80.017.000
150	80.018.000
200	80.019.000
250	80.020.000
300	80.696.000

4 slotted partitions: 27 E
2 metal dividers: 9 E
3 metal dividers: 12 E

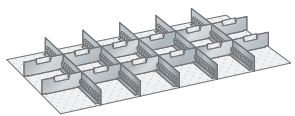

Slotted partitions and metal dividers

For front height mm	Art. no.
50	80.009.000
75	80.010.000
100, 125	80.011.000
150	80.012.000
200	80.013.000
250	80.014.000
300	80.697.000

5 slotted partitions: 27 E
12 metal dividers: 9 E

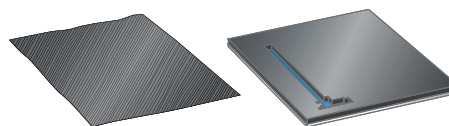

» Non-slip mats and PE foam inserts, see p. 267

Note

The front height is the same as the height of the drawer front. For the actual height of the partition material see p. 262–265.

Partition material sets excluding clip-on label holder.

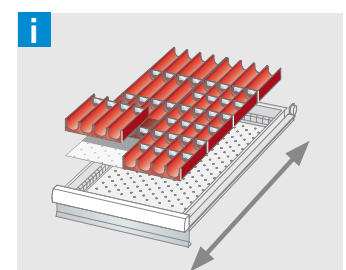

Correct use of partition material

Troughs should always be inserted in the running direction of the drawers to prevent round parts, such as drills or similar, from falling out when the drawers are closed forcefully.

18 × 36 E

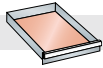

306 × 612 mm

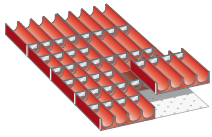

Troughs

For front height mm	Art. no.
50	80.618.000
8 troughs:	4-piece, Ø 33 mm*
40 trough dividers:	4-piece, Ø 33 mm*

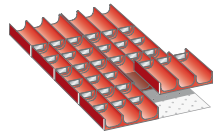

Troughs

For front height mm	Art. no.
50	80.619.000
8 troughs:	3-piece, Ø 45 mm*
30 trough dividers:	3-piece, Ø 45 mm*

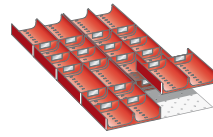

Troughs

For front height mm	Art. no.
50	80.620.000
8 troughs:	2-piece, Ø 70 mm*
20 trough dividers:	2-piece, Ø 70 mm*

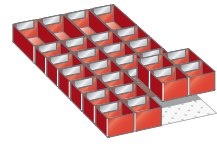

Plastic boxes

For front height mm	Art. no.
50	80.621.000
75	80.622.000
24 plastic boxes:	75 × 75 mm
4 plastic boxes:	150 × 75 mm

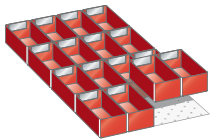

Plastic boxes

For front height mm	Art. no.
50	80.623.000
75	80.624.000
100	80.625.000
16 plastic boxes:	150 × 75 mm

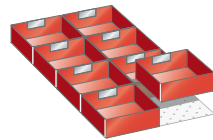

Plastic boxes

For front height mm	Art. no.
50	80.626.000
75	80.627.000
100	80.628.000
8 plastic boxes:	150 × 150 mm

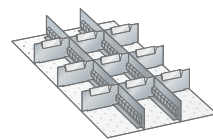

Slotted partitions and metal dividers

For front height mm	Art. no.
50	80.629.000
75	80.630.000
100	80.631.000
150	80.632.000
2 slotted partitions:	36 E
9 metal dividers:	6 E

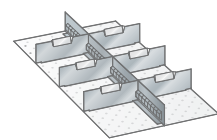

Slotted partitions and metal dividers

For front height mm	Art. no.
50	80.633.000
75	80.634.000
100	80.635.000
150	80.636.000
200	80.637.000
300	80.638.000
1 slotted partition:	36 E
6 metal dividers:	9 E



27 × 36 E

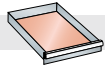

459 × 612 mm

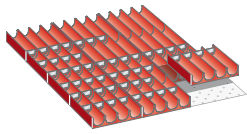

Troughs

For front height mm	Art. no.
50	100.283.000

12 troughs: 4-piece, Ø 33 mm*
50 trough dividers: 4-piece, Ø 33 mm*

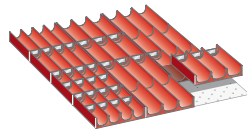

Troughs

For front height mm	Art. no.
50	100.284.000

4 troughs: 4-piece, Ø 33 mm*
20 trough dividers: 4-piece, Ø 33 mm*
8 troughs: 3-piece, Ø 45 mm*
10 trough dividers: 3-piece, Ø 45 mm*

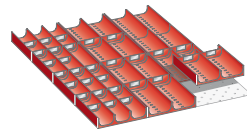

Troughs

For front height mm	Art. no.
50	100.286.000

4 troughs: 3-piece, Ø 45 mm*
20 trough dividers: 3-piece, Ø 45 mm*
8 troughs: 2-piece, Ø 70 mm*
10 trough dividers: 2-piece, Ø 70 mm*

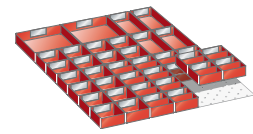

Plastic boxes

For front height mm	Art. no.
50	100.288.000

16 plastic boxes with
centre divider: 75 × 75 mm
16 plastic boxes: 75 × 75 mm
4 plastic boxes: 150 × 75 mm
2 plastic boxes: 150 × 150 mm

* Take the usable height of the drawer into account according to the goods to be stored.

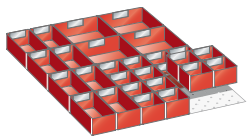

Plastic boxes

For front height mm	Art. no.
50	100.290.000
75	100.291.000

16 plastic boxes 75 × 75 mm
8 plastic boxes: 150 × 75 mm
4 plastic boxes: 150 × 150 mm

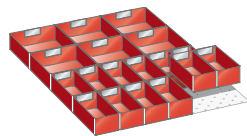

Plastic boxes

For front height mm	Art. no.
50	100.292.000
75	100.293.000
100, 125	100.294.000

12 plastic boxes 150 × 75 mm
6 plastic boxes: 150 × 150 mm

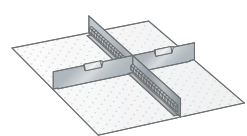

Slotted partitions and metal dividers

For front height mm	Art. no.
75	100.270.000
100, 125	100.271.000
150	100.272.000
200	100.273.000
250	80.691.000

1 slotted partition: 36 E
1 metal divider: 12 E
1 metal divider: 15 E

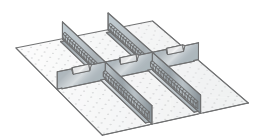

Slotted partitions and metal dividers

For front height mm	Art. no.
75	100.275.000
100, 125	100.276.000
150	100.277.000
200	100.278.000
250	80.692.000

2 slotted partitions: 36 E
3 metal dividers: 9 E

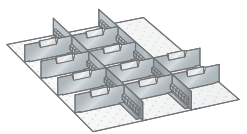

Slotted partitions and metal dividers

For front height mm	Art. no.
50	100.244.000
75	100.245.000
100, 125	100.246.000
150	100.247.000

2 slotted partitions: 36 E
10 metal dividers: 9 E

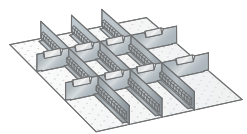

Slotted partitions and metal dividers

For front height mm	Art. no.
50	100.249.000
75	100.250.000
100, 125	100.251.000
150	100.252.000

3 slotted partitions: 36 E
6 metal dividers: 6 E
2 metal dividers: 9 E

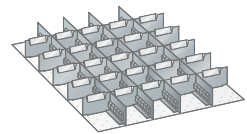

Slotted partitions and metal dividers

For front height mm	Art. no.
50	100.234.000
75	100.235.000
100, 125	100.236.000

4 slotted partitions: 36 E
15 metal dividers: 5 E
10 metal dividers: 6 E

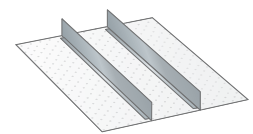

Dividers

For front height mm	Art. no.
75	100.265.000
100, 125	100.266.000
150	100.267.000
200	100.268.000
250	80.695.000

2 dividers: 36 E

Note

The front height is the same as the height of the drawer front. For the actual height of the partition material see p. 262–265.

Partition material sets excluding clip-on label holder.

36 × 36 E

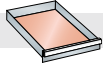

612 × 612 mm

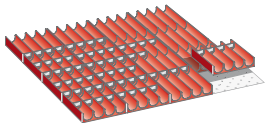

Troughs

For front height mm	Art. no.
50	100.317.000

16 troughs: 4-piece, Ø 33 mm*
70 trough dividers: 4-piece, Ø 33 mm*

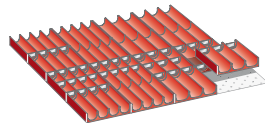

Troughs

For front height mm	Art. no.
50	100.318.000

8 troughs: 4-piece, Ø 33 mm*
30 trough dividers: 4-piece, Ø 33 mm*
8 troughs: 3-piece, Ø 45 mm*
20 trough dividers: 3-piece, Ø 45 mm*

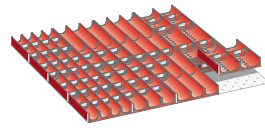

Troughs

For front height mm	Art. no.
50	100.319.000

4 troughs: 4-piece, Ø 33 mm*
30 trough dividers: 4-piece, Ø 33 mm*
8 troughs: 3-piece, Ø 45 mm*
20 trough dividers: 3-piece, Ø 45 mm*
4 troughs: 2-piece, Ø 70 mm*
10 trough dividers: 2-piece, Ø 70 mm*

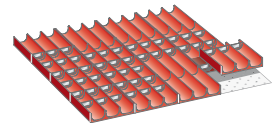

Troughs

For front height mm	Art. no.
50	100.320.000

16 troughs: 3-piece, Ø 45 mm*
60 trough dividers: 3-piece, Ø 45 mm*

* Take the usable height of the drawer into account according to the goods to be stored.

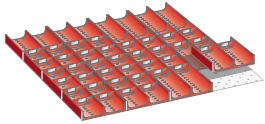

Troughs

For front height mm	Art. no.
50	100.322.000

16 troughs: 2-piece, Ø 70 mm*
40 trough dividers: 2-piece, Ø 70 mm*

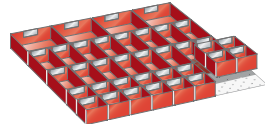

Plastic boxes

For front height mm	Art. no.
50	100.380.000
75	100.381.000

16 plastic boxes: 75 × 75 mm
16 plastic boxes: 150 × 75 mm
4 plastic boxes: 150 × 150 mm

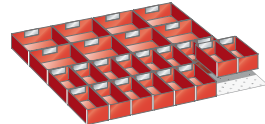

Plastic boxes

For front height mm	Art. no.
50	100.389.000
75	100.390.000
100, 125	100.391.000

16 plastic boxes: 150 × 75 mm
8 plastic boxes: 150 × 150 mm

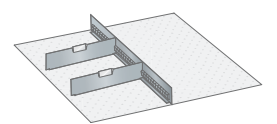

Slotted partitions and metal dividers

For front height mm	Art. no.
100, 125	100.354.000
150	100.355.000
200	100.356.000
250	80.688.000
300	100.357.000

1 slotted partition: 36 E
2 metal dividers: 18 E

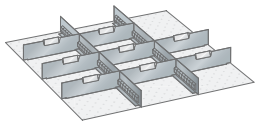

Slotted partitions and metal dividers

For front height mm	Art. no.
75	100.348.000

100, 125 100.349.000

150 100.350.000

200 100.351.000

2 slotted partitions: 36 E

8 metal dividers: 12 E

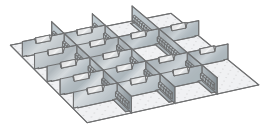

Slotted partitions and metal dividers

For front height mm	Art. no.
75	100.343.000

100, 125 100.344.000

150 100.345.000

200 100.346.000

250 80.689.000

3 slotted partitions: 36 E

15 metal dividers: 9 E

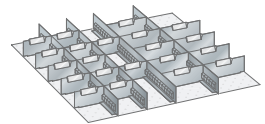

Slotted partitions and metal dividers

For front height mm	Art. no.
50	100.333.000

75 100.334.000

100, 125 100.335.000

4 slotted partitions: 36 E

12 metal dividers: 6 E

9 metal dividers: 9 E

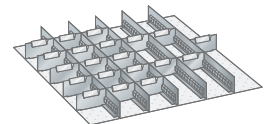

Slotted partitions and metal dividers

For front height mm	Art. no.
50	100.329.000

75 100.330.000

100, 125 100.331.000

5 slotted partitions: 36 E

20 metal dividers: 6 E

45 × 36 E

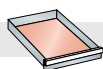

765 × 612 mm

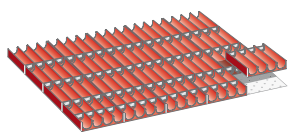

Troughs

For front height mm	Art. no.
50	80.490.000
20 troughs:	4-piece, Ø 33 mm*
80 trough dividers:	4-piece, Ø 33 mm*

* Take the usable height of the drawer into account according to the goods to be stored.

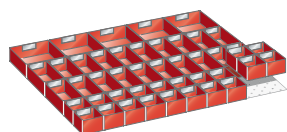

Plastic boxes

For front height mm	Art. no.
50	80.496.000
75	80.497.000
20 plastic boxes:	75 × 75 mm
20 plastic boxes:	150 × 75 mm
5 plastic boxes:	150 × 150 mm

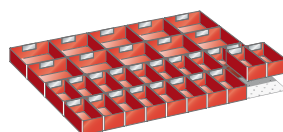

Plastic boxes

For front height mm	Art. no.
50	80.498.000
75	80.499.000
100, 125	80.500.000
20 plastic boxes:	150 × 75 mm
10 plastic boxes:	150 × 150 mm

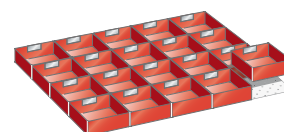

Plastic boxes

For front height mm	Art. no.
50	80.501.000
75	80.502.000
100, 125	80.503.000
20 plastic boxes:	150 × 150 mm

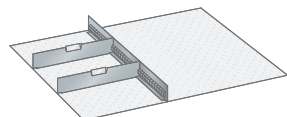

Slotted partitions and metal dividers

For front height mm	Art. no.
100, 125	100.354.000
150	100.355.000
200	100.356.000
250	80.688.000
300	100.357.000
1 slotted partition:	36 E
2 metal dividers:	18 E

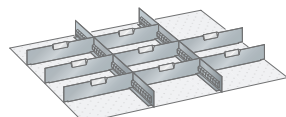

Slotted partitions and metal dividers

For front height mm	Art. no.
100, 125	80.504.000
150	80.505.000
200	80.506.000
250	80.507.000
300	80.508.000
2 slotted partitions:	36 E
8 metal dividers:	15 E

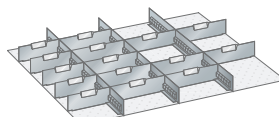

Slotted partitions and metal dividers

For front height mm	Art. no.
75	80.509.000
100, 125	80.510.000
150	80.511.000
200	80.512.000
3 slotted partitions:	36 E
5 metal dividers:	9 E
10 metal dividers:	12 E

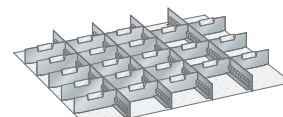

Slotted partitions and metal dividers

For front height mm	Art. no.
75	80.513.000
100, 125	80.514.000
150	80.515.000
200	80.516.000
250	80.517.000
4 slotted partitions:	36 E
21 metal dividers:	9 E



Note

The front height is the same as the height of the drawer front. For the actual height of the partition material see p. 262–265.

Partition material sets excluding clip-on label holder.

54 × 36 E

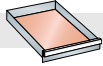

918 × 612 mm

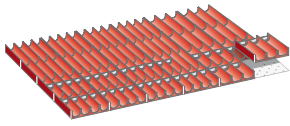

Troughs

For front height mm	Art. no.
50	80.387.000
16 troughs:	4-piece, Ø 33 mm*
30 trough dividers:	4-piece, Ø 33 mm*
8 troughs:	3-piece, Ø 45 mm*
10 trough dividers:	3-piece, Ø 45 mm*

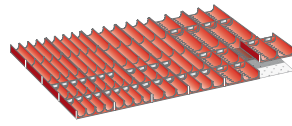

Troughs

For front height mm	Art. no.
50	80.388.000
8 troughs:	4-piece, Ø 33 mm*
20 trough dividers:	4-piece, Ø 33 mm*
8 troughs:	3-piece, Ø 45 mm*
10 trough dividers:	3-piece, Ø 45 mm*
8 troughs:	2-piece, Ø 70 mm*
10 trough dividers:	2-piece, Ø 70 mm*

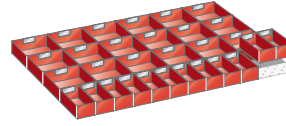

Plastic boxes

For front height mm	Art. no.
50	80.449.000
75	80.405.000
100, 125	80.406.000
12 plastic boxes:	150 × 75 mm
18 plastic boxes:	150 × 150 mm

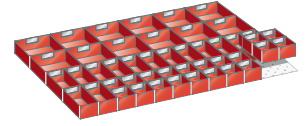

Plastic boxes

For front height mm	Art. no.
50	80.450.000
75	80.407.000
20 plastic boxes:	75 × 75 mm
14 plastic boxes:	150 × 75 mm
12 plastic boxes:	150 × 150 mm

*Take the usable height of the drawer into account according to the goods to be stored.

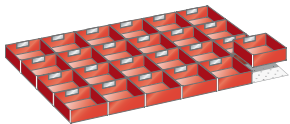

Plastic boxes

For front height mm	Art. no.
50	80.451.000
75	80.452.000
100, 125	80.453.000
24 plastic boxes:	150 × 150 mm

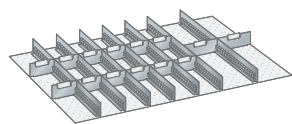

Slotted partitions and metal dividers

For front height mm	Art. no.
50	80.481.000
75	80.403.000
100, 125	80.404.000
7 slotted partitions:	36 E
12 metal dividers:	6 E
2 metal dividers:	9 E

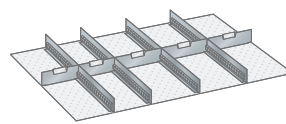

Slotted partitions and metal dividers

For front height mm	Art. no.
50	80.533.000
75	80.389.000
100, 125	80.390.000
150	80.391.000
200	80.392.000
250	80.393.000
300	80.394.000

4 slotted partitions: 36 E
2 metal dividers: 9 E
3 metal dividers: 12 E

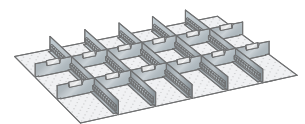

Slotted partitions and metal dividers

For front height mm	Art. no.
50	80.479.000
75	80.395.000
100, 125	80.396.000
150	80.397.000
200	80.398.000
250	80.399.000
300	80.400.000

5 slotted partitions: 36 E
12 metal dividers: 9 E

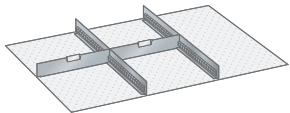

Dividers

For front height mm	Art. no.
50	80.457.000
75	80.458.000
100, 125	80.459.000
150	80.460.000
200	80.461.000
250	80.462.000
300	80.463.000

2 slotted partitions: 36 E
2 metal dividers: 18 E

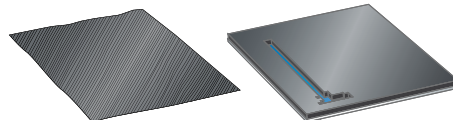

» Non-slip mats and PE foam inserts, see p. 267

Note

The front height is the same as the height of the drawer front. For the actual height of the partition material see p. 262–265.

Partition material sets excluding clip-on label holder.

64 × 36 E

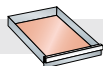

1088 × 612 mm

78 × 36 E

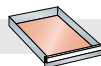

1326 × 612 mm

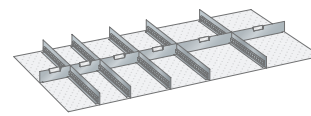
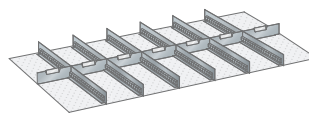
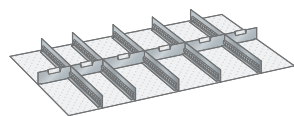
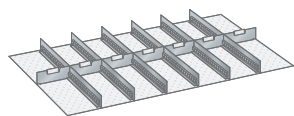

Slotted partitions and metal dividers

For front height mm	Art. no.
50	80.600.000
100, 125	80.601.000
150	80.602.000

6 slotted partitions: 36 E
6 metal dividers: 9 E
1 metal divider: 10 E

Slotted partitions and metal dividers

For front height mm	Art. no.
75	80.603.000
100, 125	80.604.000
150	80.605.000

5 slotted partitions: 36 E
2 metal dividers: 9 E
3 metal dividers: 12 E
1 metal divider: 10 E

Slotted partitions and metal dividers

For front height mm	Art. no.
75	80.553.000
100, 125	80.554.000
150	80.555.000

6 slotted partitions: 36 E
4 metal dividers: 9 E
2 metal dividers: 12 E
1 metal divider: 18 E

Slotted partitions and metal dividers

For front height mm	Art. no.
75	80.556.000
100, 125	80.557.000
150	80.558.000

5 slotted partitions: 36 E
2 metal dividers: 9 E
2 metal dividers: 12 E
2 metal dividers: 18 E



Partition material | Slotted partitions, metal dividers and dividers



Slotted partitions, both sides

For lengthwise partitioning of drawers in combination with metal dividers. Specification: Steel sheet, colour: Grey, NCS S 4502-B.

Metal dividers

Together with the slotted partitions, they can be used to subdivide the drawers as desired. Specification: Aluminium

Dividers

For lengthwise and crosswise partitioning of drawers. Specification: Steel sheet, colour: Grey, NCS S 4502-B.

H ↑ Drawer front height
mm

W_i → Length
mm

Dividers

18 E	304
27 E	456
36 E	610
45 E	762
54 E	915
64 E	1085
78 E	1323

D₁ ↗ Length
mm

Slotted partitions, both sides

27 E	456
36 E	610

Metal dividers **W_i** →

3 E	48
4 E	65
5 E	82
6 E	98
7 E	116
8 E	133
9 E	149
10 E	167
12 E	201
15 E	252
18 E	303

How do I use the slotted partitions, metal dividers and dividers in my LISTA drawer?

Example: for drawer units 45 × 36 E (765 × 612 mm)

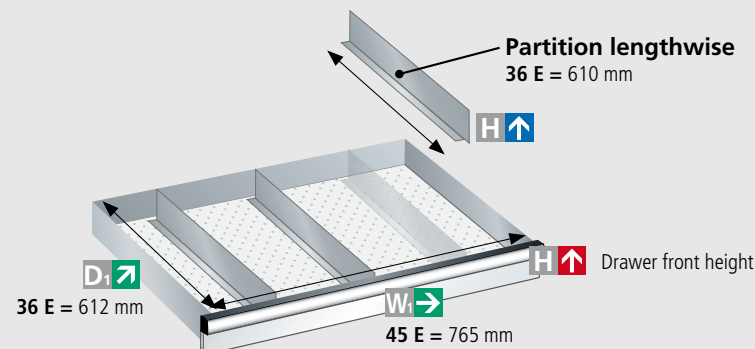
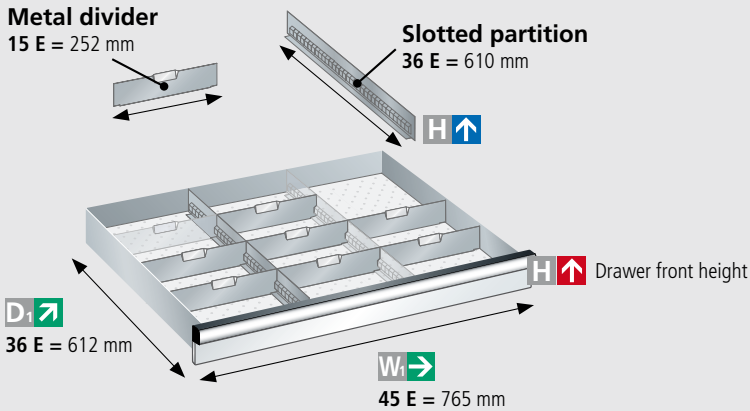

50 mm	75 mm	100, 125 mm	150 mm	200 mm	250 mm	300 mm
31,5	50	75	125	175	225	275
Art. no.	Art. no.	Art. no.	Art. no.	Art. no.	Art. no.	Art. no.
1 pcs/set	1 pcs/set	1 pcs/set	1 pcs/set	1 pcs/set	1 pcs/set	1 pcs/set
12.088.000	12.121.000	12.089.000	12.090.000	12.122.000	-	12.091.000
80.237.000	80.121.000	80.127.000	80.133.000	80.139.000	80.222.000	80.243.000
80.239.000	80.123.000	80.129.000	80.135.000	80.141.000	80.225.000	80.144.000
80.541.000	80.542.000	80.543.000	80.544.000	80.545.000	80.546.000	80.547.000
80.178.000	80.179.000	80.180.000	80.181.000	80.182.000	80.183.000	80.184.000
-	80.124.000	80.130.000	80.136.000	80.142.000	80.228.000	80.229.000
-	80.125.000	80.131.000	80.137.000	80.143.000	80.685.000	80.233.000
Art. no.	Art. no.	Art. no.	Art. no.	Art. no.	Art. no.	Art. no.
5 pcs/set	5 pcs/set	5 pcs/set	5 pcs/set	3 pcs/set	3 pcs/set	3 pcs/set
80.307.000	80.308.000	80.309.000	80.310.000	80.311.000	80.312.000	80.313.000
80.314.000	80.315.000	80.316.000	80.317.000	80.318.000	80.319.000	80.320.000
Art. no.	Art. no.	Art. no.	Art. no.	Art. no.	Art. no.	Art. no.
5 pcs/set	5 pcs/set	5 pcs/set	5 pcs/set	5 pcs/set	5 pcs/set	5 pcs/set
95.261.000	95.272.000	95.302.000	-	-	-	-
95.262.000	95.273.000	95.303.000	-	-	-	-
95.263.000	95.274.000	95.304.000	-	-	-	-
95.264.000	95.275.000	95.305.000	95.313.000	-	-	-
95.265.000	95.276.000	95.306.000	95.314.000	95.321.000	-	-
95.266.000	95.277.000	95.307.000	95.315.000	95.322.000	95.328.000	-
95.267.000	95.278.000	95.308.000	95.316.000	95.323.000	95.329.000	95.368.000
95.268.000	95.279.000	95.309.000	95.317.000	95.324.000	95.330.000	95.369.000
95.269.000	95.280.000	95.310.000	95.318.000	95.325.000	95.365.000	95.370.000
95.270.000	95.300.000	95.311.000	95.319.000	95.326.000	95.366.000	95.371.000
95.271.000	95.301.000	95.312.000	95.320.000	95.327.000	95.367.000	95.372.000
					10 pcs/set	
					134.002.000	

Extruded screws for metal dividers: Screws for fastening the metal dividers to the drawer bottom.

Clip-on label holders for slotted partitions

for fitting into all slotted partitions and the inner slots of the drawer fronts. Labels not included.



Label size (W × H) mm	Quantity	Art. no.
27 × 12	10 holders	80.305.000
47 × 12	10 holders	80.306.000

Clip-on label holders for slotted partitions, metal dividers and divider including labels.



Label size (W × H) mm	Quantity	Art. no.
27 × 12	20 tabs	134.029.000
47 × 12 (size 5 E)	20 tabs	134.049.000
47 × 18 (size 5 E)	20 tabs	134.052.000

Barcode holder including protective shield for slotted partitions, metal dividers and dividers including labels.

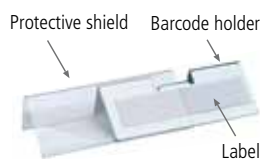

Label size (W × H) mm	For drawer front height mm	Quantity	Art. no.
47 × 12	50 to 300	10	80.321.000
62 × 12	50 to 300	10	80.322.000
62 × 21,8	50 to 300	10	80.323.000
62 × 29	75 to 300	10	80.324.000

LISTA-Script labels "Standard pack"

The labelling software can be downloaded from the LISTA website www.lista.com under Products › Accessories › LISTA Script.



Label size (W × H) mm	Quantity	Art. no.
210 × 22 / 70 × 22	2 sheets	80.325.000
47 × 12	76 labels	
47 × 18	52 labels	
27 × 12	133 labels	

Partition material | Plastic boxes and troughs



Especially suitable for drawers with a front height of: 50, 75, 100, 125 mm

How can I partition my LISTA drawer?

Example: Plastic boxes and troughs for drawers 36 × 27 E (612 × 459 mm)

* The plastic box also has a fixed centre divider.

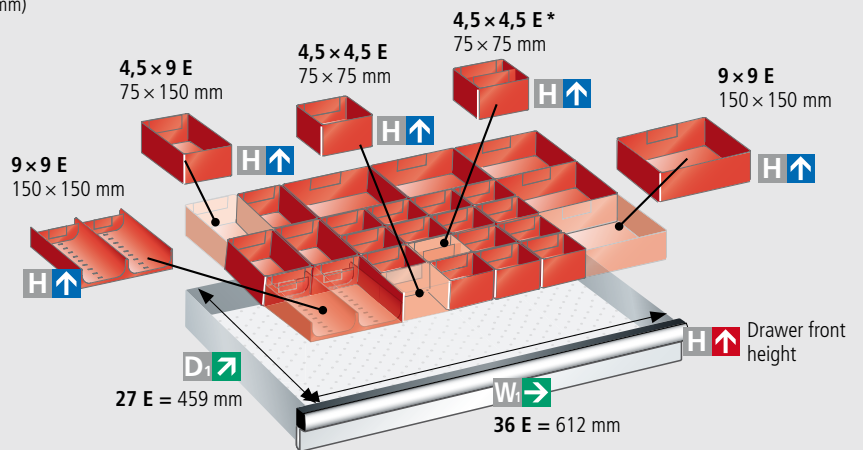
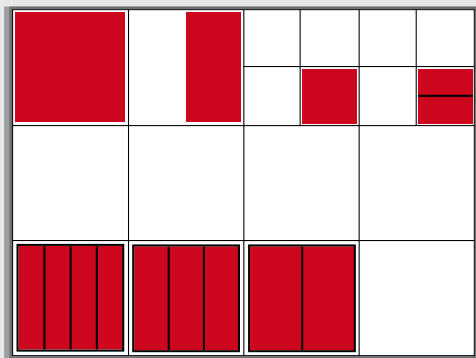

Perfect drawer partitioning

Store your small and round parts professionally and perfectly in the LISTA drawers with LISTA plastic boxes and troughs.

The table on the right shows the maximum capacity of your drawer for each size of plastic boxes and troughs. The dimensions are standardised but can be combined if desired and fit into any LISTA drawer.

Please bear the front height of your drawer in mind (external dimension)!

Maximum capacity per plastic box for:

9 × 9 E

150 × 150 mm



Number of plastic boxes/troughs

4,5 × 9 E

75 × 150 mm



Number of plastic boxes

4,5 × 4,5 E

75 × 75 mm



Number of plastic boxes

Drawer units (E)

W1 → D1 ↗

Drawer units (E)	Dimensions	9 × 9 E 150 × 150 mm	4,5 × 9 E 75 × 150 mm	4,5 × 4,5 E 75 × 75 mm
18 × 27	306 × 459 mm	6	12	24
27 × 27	459 × 459 mm	9	18	36
36 × 27	612 × 459 mm	12	24	48
54 × 27	918 × 459 mm	18	36	72
18 × 36	306 × 612 mm	8	16	32
27 × 36	459 × 612 mm	12	24	48
36 × 36	612 × 612 mm	16	32	64
45 × 36	765 × 612 mm	20	40	80
54 × 36	918 × 612 mm	24	48	96
64 × 36	1088 × 612 mm	28	56	112
78 × 36	1326 × 612 mm	32	68	136

Plastic boxes, standard



	9 × 9 E	4,5 × 9 E	4,5 × 4,5 E	4,5 × 4,5 E
	150 × 150 mm	75 × 150 mm	75 × 75 mm	75 × 75 mm
H ↑ Drawer front height (mm)				
H ↑ Height (mm)				
Art. no.				
	6 pcs/set	6 pcs/set	12 pcs/set	12 pcs/set
50	80.187.000	80.191.000	80.189.000	80.185.000*
75	80.186.000	80.190.000	80.188.000	-
100	80.192.000	80.193.000	-	-

* The plastic box Art. no. 80.185.000 also has a fixed centre divider.

Troughs, standard



	9 × 9 E (150 × 150 mm)		
	Ø 33 mm, 4 troughs	Ø 45 mm, 3 troughs	Ø 70 mm, 2 troughs
Art. no.			
	6 pcs/set	6 pcs/set	6 pcs/set
80.196.000	80.195.000	80.194.000	80.194.000
Dividers, 10 pieces	10 pcs/set	10 pcs/set	10 pcs/set
134.044.000	134.040.000	134.020.000	134.020.000

Specification

Troughs, 9 × 9 E, 6 pieces

6 pcs/set

Dividers, 10 pieces

10 pcs/set

» Plastic boxes/troughs also available in ESD.

N.B.: Take the usable height of the drawer into account according to the goods to be stored.

Clip-on label holders for plastic boxes

for inserting into the groove on the plastic boxes. Including labels and transparent sheets.



Label size (W × H) mm	Quantity	Art. no.
47 × 12	20 tabs	134.034.000

Clip-on label holders for dividers

fit directly onto the dividers. Including paper and transparent sheet.



Label size (W × H) mm	Quantity	Art. no.
27 × 12	20 tabs	134.029.000
47 × 12 (Ø 70 mm)	20 tabs	134.049.000

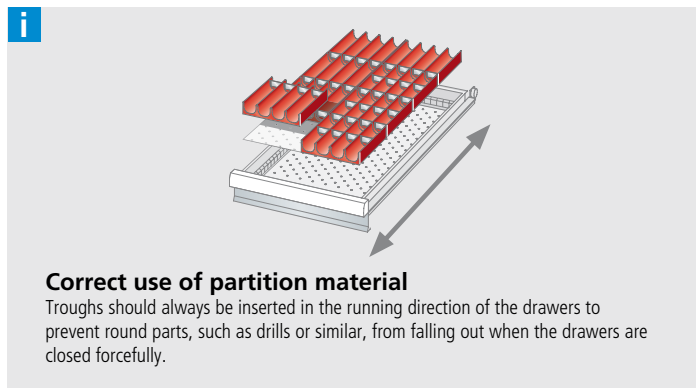

LISTA-Script labels "Standard pack"

The labelling software can be downloaded from the LISTA website www.lista.com under Products > Accessories > LISTA Script.



Label size (W × H) mm	Quantity	Art. no.
210 × 22 / 70 × 22	2 sheets	80.325.000
47 × 12	76 labels	
47 × 18	52 labels	
27 × 12	133 labels	

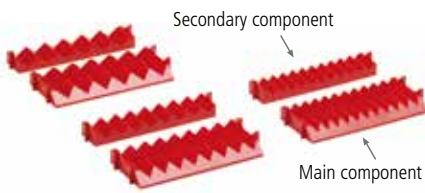

Pairs of grooved inserts

Consisting of main and secondary components. They are attached by inserting between two slotted partitions. They can be divided by metal separators. Main components slotted for dividing into small compartments or marking with label holders. Specification: ABS plastic. Colour: red. Main component: width 153 mm/9 E, depth 68 mm/4 E. Secondary component: width 153 mm/9 E, depth 34 mm/2 E.

Number of grooves	Max. tool Ø mm	Art. no.
6	20,5	80.078.000
8	15	80.079.000
11	10	80.080.000

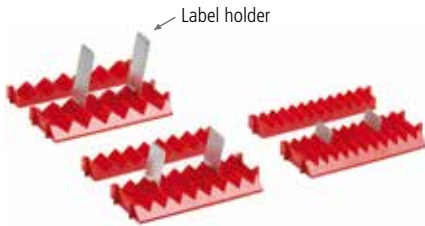

Label holders

Specification: aluminium, for labelling.

Width mm	Height mm	Art. no.
29	25	100.527.000
29	50	100.521.000
29	75	100.522.000



Milling cutter holder, height 26 mm

The milling cutter holders can be lengthened as desired by screwing them on top of one another. They are screwed onto the perforated drawer bottom. Including screw nuts. Specification: ABS plastic. Colour: red.

For tool bore (DIN) Ø mm	Ø mm	Inch	Number	Art. no.
13	12,2	1/2	5	80.765.000
16	15,5	-	5	80.766.000
22	21,5	-	5	80.767.000
25,5	25	1	5	100.103.000
27	26,5	-	5	100.099.000
32	31,2	-	5	100.100.000
38	37,5	1 1/2	5	100.104.000
40	39,5	-	5	100.101.000
50	49,5	-	5	100.102.000



Holding pins

For positioning and holding irregularly shaped tools. The holding pins are screwed onto the perforated drawer bottom. Including screw nuts. Specification: round steel, bright galvanised.

For front height mm	Ø mm	Height mm	Number	Art. no.
50	6	27	10	134.036.000
75	6	52	10	134.054.000
100	6	77	10	134.057.000



Pair of angular supports, height 52 mm

The pair of angular supports can be screwed horizontally or vertically onto the perforated drawer bottom. Screw fasteners included. Specification: ABS plastic. Colour: red.

Width mm	Depth mm	Art. no.
25	75	80.077.000

Non-slip mats

Non-slip mats to protect delicate inventory items. For placing onto the bottom of the drawer. Specification: nylon/PVC mesh mats. Colour: anthracite.

For drawer sizes Unit (E)	Width mm	Depth mm	Thickness mm	Art. no.
18 × 27	300	450	3	119.001.000
18 × 36	300	600	3	119.000.000
27 × 27	450	450	3	119.020.000
27 × 36, 36 × 27	450	600	3	100.396.000
36 × 36	600	600	3	100.394.000
45 × 36	750	600	3	130.743.000
54 × 27	900	450	3	119.119.000
54 × 36	900	600	3	130.745.000
64 × 36	1080	600	3	119.028.000
78 × 36	1320	600	3	119.031.000



Foam inserts

For storing very delicate or irregularly shaped parts. To achieve a snug fit, areas can be cut out of the foam with plunge cutters. Specification: polyethylene plastic. Colour: black.

For drawer sizes Unit (E)	Width mm	Depth mm	Thickness mm	Art. no.
36 × 27, 27 × 36	600	447	22	80.917.000
36 × 36	600	600	22	80.918.000
54 × 27	906	447	22	80.923.000
54 × 36	906	600	22	80.919.000
78 × 36	1320	600	22	80.980.000

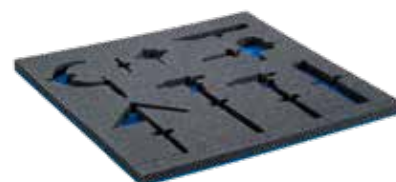

Underlay for foam inserts

Specification: polyethylene plastic. Colour: blue.

For drawer sizes Unit (E)	Width mm	Depth mm	Thickness mm	Art. no.
36 × 27, 27 × 36	600	447	3	80.906.000
36 × 36	600	600	3	80.907.000
54 × 27	906	447	3	80.924.000
54 × 36	906	600	3	80.908.000
78 × 36	1320	600	3	80.981.000

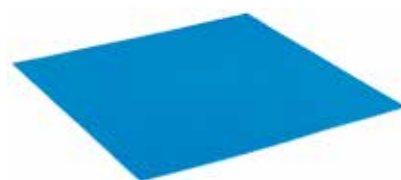

Plunge cutter for foam inserts

For accurate cutting of the blank PE foam inserts.

Width mm	Height mm	Art. no.
20	80	80.920.000
50	80	80.921.000
20 × 20 "U" shape	80	80.922.000



LISTA Script labelling system

With **LISTA Script**, your **LISTA** products can be simply and clearly labelled. The labelling software can be downloaded from our website. The matching labels are supplied as perforated A4 sheets suitable for any commercially available printer. There are almost no limits to the ways you can design labels. As always with **LISTA**.



+ Individual labelling
with a wide range of labelling options, colours, pictograms and barcode generator

+ Software can easily be downloaded
via www.lista.com under Products › Accessories › LISTA Script

+ Easy to use
with any commercially available printer and pre-perforated labels

+ Fast data import
via database link

+ Easy to use in three simple steps



1. Design

- Design the labels using LISTA Script labelling software



2. Print

- Print the labels on perforated A4 sheets and detach them in the desired size



3. Insert

- Open the viewing window, insert the label and close the viewing window by pressing the bottom edge

+ Pre-perforated labels for cabinets and partition material

LISTA labels are available in the sizes 70 × 22 mm, 140 × 22 mm and 210 × 22 mm for cabinet labelling and 27 × 12 mm, 47 × 12 mm and 47 × 18 mm for labelling partition material.

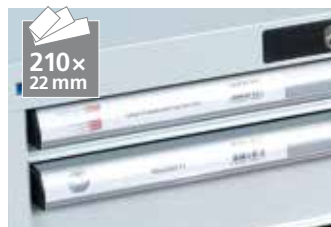

Label size 210 × 22 mm
for labelling drawers



Label size 70 × 22 mm
for labelling housing



Label size 70 × 22 mm
for labelling drawers



All labels
on perforated A4 sheets



Label size 27 × 12 mm
for labelling troughs



Label size 47 × 12 mm
for labelling plastic boxes

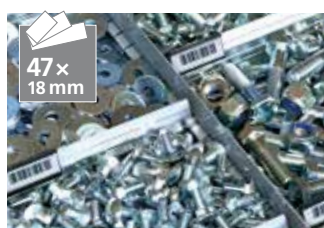

Label size 47 × 18 mm
for labelling dividers

LISTA Script labels "Standard pack"

Label size (W × H) mm							Quantity	Art. no.
210 × 22 / 70 × 22	●	●	-	-	-	-	2 sheets	80.325.000
27 × 12	-	-	●	●	●	●	133 labels	
47 × 12	-	-	-	●	●	●	76 labels	
47 × 18	-	-	-	-	●	-	52 labels	

* Clip-on label holders

To hold clip-on label holders, for fitting into the slots inside the drawer fronts, see partition material p. 262.



Label strips with and without labels

For labelling shelves, clothes lockers, etc. Specification: plastic, with hinged transparent protector, self-adhesive.

Width mm	labels	Height mm	Max. font height mm	Quantity	Art. no.
105	-	22	14	1	18.926.000
210	-	22	14	1	18.927.000
1000	-	22	14	1	18.929.000
105	●	22	14	10	18.930.000
210	●	22	14	10	18.931.000

● with labels - without labels

LISTA Script labels for label strips



Label size (W × H) mm	Quantity	Art. no.
52,5 × 18	2 A4 sheets with 52 labels each	18.932.000

» For drawer handles and disassembly tools, please contact us.

THERE FOR YOU ALL OVER THE WORLD

LISTA is there for you, on several continents, in many different locations. In addition to our two plants at the headquarters in Erlen (Switzerland) and in Bergneustadt (Germany), we also look after and advise our customers through our international sales branches in Europe and China. A close-knit network of retail partners tops off the service that we offer.



LISTA Group locations

Switzerland, Germany, Austria, France, Italy, England, Spain, China



Founding

1945

Headquarters

Erlen (TG), Switzerland



Production sites

Erlen (CH), Bergneustadt (DE)

ORDERING AND CONTACT

Lista AG
Switzerland

Fabrikstrasse 1
CH-8586 Erlen

Telephone +41 71 649 21 11
Fax +41 71 649 22 03
info@lista.com

Lista GmbH
Germany

Brückenstrasse 1
D-51702 Bergneustadt

Telephone +49 2261 40 30
Fax +49 2261 40 32 22
info.de@lista.com

Lista Austria GmbH
Austria

Telephone +43 1 291 20
Fax +43 1 291 204
info.at@lista.com

Lista (UK) Ltd.
United Kingdom

Telephone +44 1 908 222 333
Fax +44 1 908 222 433
info.uk@lista.com

Lista Italia s.r.l.
Italy

Telephone +39 02 935 70 196/362
Fax +39 02 935 70 417
info.it@lista.com

Lista France
France

Telephone + 33 4 50 31 71 71
Fax + 33 4 50 31 71 79
info.fr@lista.com

Lista Sistemas de
Almacenaje, S.A.
Spain

Telephone +34 938 575 927
info.es@lista.com